

Universal joint shaft SWC Series

Type BH
Standard flexible welded type

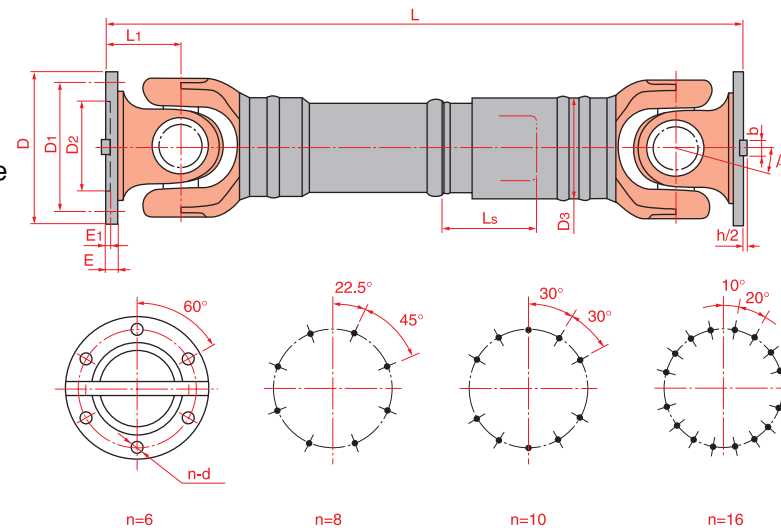

Type BF
Standard flexible welded type

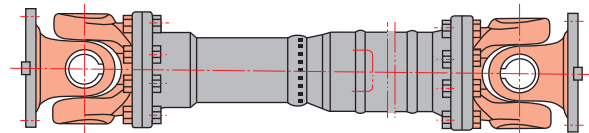

Type DH
Short flexible welded type

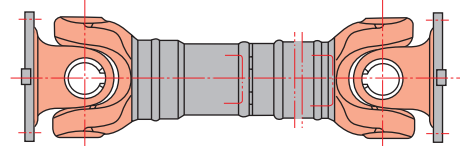

Type CH
Long flexible welded type

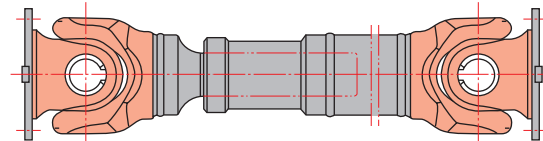

Type WH
Non-flexible welded type

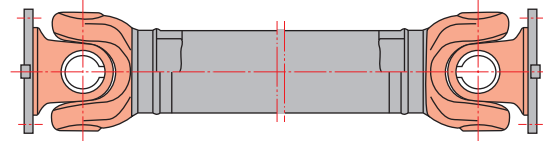

Type WF
Non-flexible flanged type

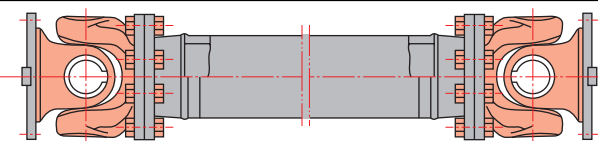

Type WD
Short non-flexible type

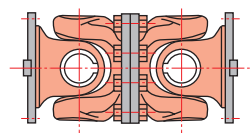

Universal joint shaft SWC Series

Parameters and Specifications of Coupling Model SWC

Table 1

Model	Gyration dia. D	Nominal angular force Tn kN·m	Fatigue angular force TK kN·m	Axis angle β ≤	Dimensions mm								
					D1	D2 H7	D3	L1	n-d	E	E1	b h9	h/2
SWC100 □	100	1.25	0.63	25°	84	57	60	55	6-9	7	2.5	-	-
SWC120 □	120	2.5	1.25	25°	102	75	70	65	8-11	8	2.5	-	-
SWC150 □	150	5	2.5	25°	130	90	89	80	8-13	10	3.0	-	-
SWC180 □	180	12.5	6.3	25°	155	105	114	110	8-17	17	5.0	-	-
SWC225 □	225	40	20	15°	196	135	152	120	8-17	20	5.0	32	9.0
SWC250 □	250	63	31.5	15°	218	150	168	140	8-19	25	6.0	40	12.5
SWC285 □	285	90	45	15°	245	170	194	160	8-21	27	7.0	40	15.0
SWC315 □	315	125	63	15°	280	185	219	180	10-23	32	8.0	40	15.0
SWC350 □	350	180	90	15°	310	210	267	194	10-23	35	8.0	50	16.0
SWC390 □	390	250	125	15°	345	235	267	215	10-25	40	8.0	70	18.0
SWC440 □	440	355	180	15°	390	255	325	260	16-28	42	10.0	80	20.0
SWC490 □	490	500	250	15°	435	275	325	270	16-31	47	12.0	90	22.5
SWC550 □	550	710	355	15°	492	320	426	305	16-31	50	12.0	100	22.5
SWC620 □	620	1000	500	15°	555	380	426	340	10-38	55	12.0	100	25

Table 2

Type	Parameters	Gyration dia.													
		100	120	150	180	225	250	285	315	350	390	440	490	550	620
BH	Min. Length Lmin	410	485	590	860	920	1035	1190	1315	1410	1590	1875	1985	2300	-
	Weight (kg)	7	12	26	75	130	180	273	389	601	758	1210	1602	2503	-
	Flex LS	55	80	80	100	140	140	140	140	150	170	190	190	240	-
BF	Min. Length Lmin	-	-	-	810	920	1035	1190	1315	1410	1590	1875	1985	2300	2500
	Weight (kg)	-	-	-	90	148	210	315	440	662	857	1380	1731	2667	3367
	Flex LS	-	-	-	100	140	140	140	140	150	170	190	190	240	240
DH	Min. Length Lmin	-	-	-	550	640	735	880	980	1070	1200	-	-	-	-
	Weight (kg)	-	-	-	62	102	148	240	350	500	655	-	-	-	-
	Flex LS	-	-	-	40	70	70	80	90	90	90	-	-	-	-
CH	Min. Length Lmin	-	-	-	925	1080	1215	1475	1600	1715	1845	2110	2220	2585	-
	Weight (kg)	-	-	-	103	180	230	350	510	820	960	1530	1760	3000	-
	Flex LS	-	-	-	200	200	300	400	400	400	400	400	400	500	-
WH	Min. Length Lmin	243	307	350	480	520	620	720	805	875	955	1155	1205	1355	-
	Weight (kg)	5	8.5	20	52	85	144	215	302	415	566	870	1140	1630	-
WF	Min. Length Lmin	-	-	-	560	610	715	810	915	980	1100	1290	1360	1510	1690
	Weight (kg)	-	-	-	58	104	150	240	332	452	668	980	1274	1763	2442
WD	Length L	-	-	-	440	480	560	640	720	776	860	1040	1080	1220	1360
	Weight (kg)	-	-	-	60	90	140	201	291	395	554	854	1156	1624	2220
On every weight increase of 100 Kg		0.35	0.55	0.85	2.8	4.9	5.3	6.3	8	15	15	21.7	21.7	34	34